

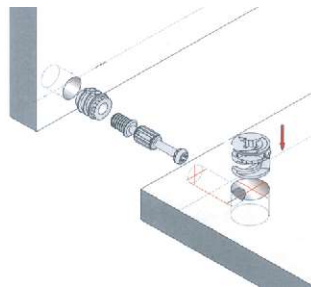

ACCESSORY

*Accessory
by
OSLASA Spain*

INNOVATIVE FUNCTIONS AND DESIGN

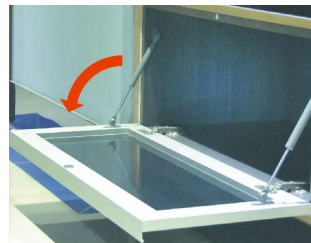

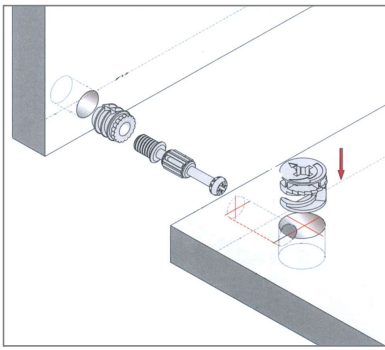

SCK-318A/N

Desc.: OSLASA Cam
 Size: Φ 12x10mm
 Col.: Zinc alloy
 Col.: Nickel

Features

OSLASA Cam offers the furniture manufacturer the advantage gained by using a single cam to activate M6 bolt, Self-expanding bolt and Wood threaded bolt

Application

- The cam is simply hand, or machine, inserted into the 12mm diameter face hole.
- Cams are available for 12 ~16mm board thickness.

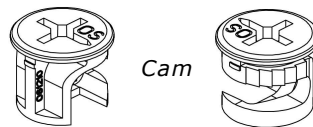
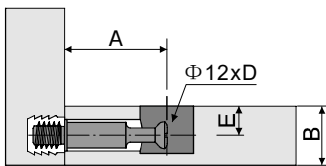

Code No.	B	D	E	
SCK-318A/N	12-16mm	10mm	5.5-6mm	2000

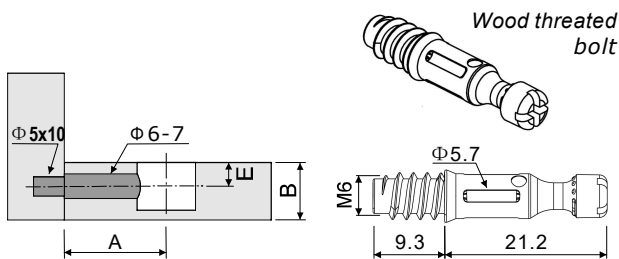

SCK-318B/N

Desc.: Wood threaded bolt
 Material: Zinc alloy
 Col.: Nickel

Application

- Suitable for use with OSLASA Cam products;
- locking feature provides a strong, vibration proof joint;

Code No.	Description	A	
SCK-318B/N	Thread results in reduced insertion times	20mm	2000

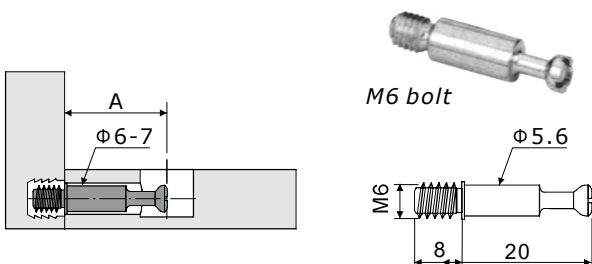

SCK-318C/N

Desc.: M6 bolt
 Material: Steel
 Col.: Nickel

Application

- Suitable for use with OSLASA Cam products;

Code No.	Description	A	
SCK-318C/N	Thread results in reduced insertion times	20mm	2000